

Mechanical valve

CM3 Series

Product feature

- The external force required by direction-change of CM3B, CM3L, CM3V and CM3R is provided by external mechanism, which can be used for position test or stroke switch;
- CM3PF, CM3PM, CM3PL, CM3HS, CM3HD and CM3Y are operated manually, owning control joints with several structure forms and suitable for application under different conditions;
- It is in cut-off structure. Internal circle is sealed with good tightness, the direction-change is sensitive and lubricant is not necessary;
- Multi-mounting method makes it convenient to install and apply;
- The control joint of series of CM3L, CM3V, CM3R and CM3Y are made of metal which has longer service life and more reliable and steady performance.

Ordering code

CM3 PP - 06 - B - P

Port size	Button color	Thread type
05: M5	R: Red	P: PT
06: 1/8"	G: Green	T: NPT
08: 1/4"	B: Black	G: G
	Y: Yellow	

①

Valve's type
CM3: CM type 3/2 way

Model

B: Basic type
R: Roller type
L: Roller with free return type
V: vertical roller type
Y: Lever type

No option for bottom color

PL: Latching type (only red)

PP: Protruding type
PF: Flat type
PM: Mushroom type
HS: Selector type
HD: Double-selector type

R: Red
G: Green
B: Black
Y: Yellow

Note: ① When the thread is M5 type, the code is blank.

Specification

Model	CM3□-05	CM3□-06	CM3□-08
Operating	External control		
Fluid	Air (to be filled by 40μm filter element)		
Pressure range	0 ~ 1.0MPa (0 ~ 145psi) (0 ~ 10.0bar)		
Proof pressure	1.5MPa (215psi) (15.0bar)		
Temperature	-20 ~ 70°C		
Value type	3 port 2 position		
Orifice size	2.0mm ²	2.5mm ²	15.0mm ²
Cv value	0.11	0.14	0.84
Port size ①	M5X0.8	1/8"	1/4"
Material of body	Aluminium		

Note: ① PT thread ,NPT thread and G thread are available.

Inner structure

CM3V

NO.	Item	NO.	Item
1	Fixing plate	12	Shaft
2	Screw	13	Lock pin
3	Spacer	14	Roller bracket
4	Body	15	Spring
5	Spring	16	O-ring
6	Spool	17	Screw
7	Connecting gasket	18	O-ring
8	Connecting holder	19	Bottom cover gasket
9	Clamping nut	20	Spring
10	Spring gasket	21	O-ring
11	Roller		



Symbol



Installation and operation

- Assembly way: by body, by panel I, by panel II, latching type, mushroom type. Please refer to the following picture:

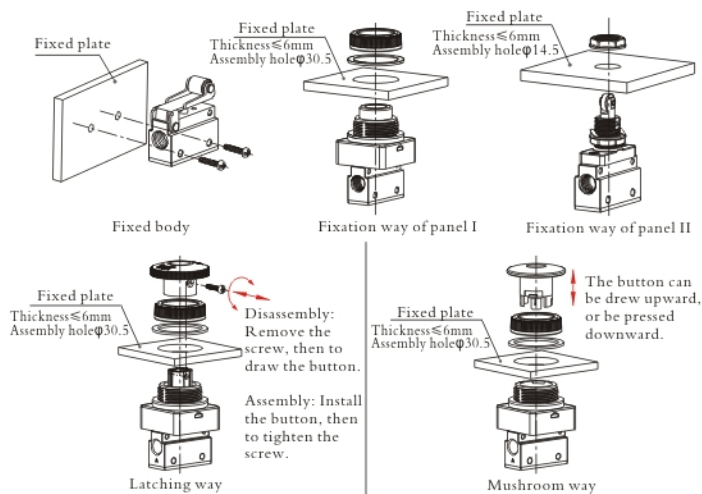

- The control set is made of engineering plastic which only allows manual operation and switching valves through metal impact is forbidden.
- The series of CM3B, CM3L, CM3V, CM3R, CM3PF and CM3PP get the function of automatic restoration. The hand valves of CM3Y, CM3HS, CM3HD, CM3PL are in type of manual restoration. CM3PL will be restored by turning the revolve button after being pressed into orientation.
- Pay attention to the reversing stroke. The reversing stroke can not surpass its stroke stipulated in stroke control table when the direction-change of the valve is forced by any external forces, otherwise it will cause the damage of the valve.

Type	Spool stroke	Button (Roller/handle) stroke	Type	Spool stroke	Button (roller/handle) stroke
CM3B-05(06)	1.5-3.0	-	CM3B-08	2.4-4.0	-
CM3L-05(06)	1.5-2.3	3.0-4.8	CM3L-08	2.4-3.2	7.2-9.7
CM3R-05(06)	1.5-2.5	3.0-4.8	CM3R-08	2.4-3.2	6.8-9.0
CM3V-05(06)	1.5-3.0	2.7-4.2	CM3V-08	2.4-4.0	2.6-4.2
CM3PL-05(06)	1.5-2.5	4.0-5.0	CM3PL-08	2.4-3.5	4.0-5.0
CM3PM-05(06)	1.5-3.0	4.0-5.5	CM3PM-08	2.4-4.0	4.0-5.5
CM3PF-05(06)	1.5-3.0	4.0-5.5	CM3PF-08	2.4-4.0	4.0-5.5
CM3PP-05(06)	1.5-3.0	4.0-5.5	CM3PP-08	2.4-4.0	4.0-5.5

- The CM3L can only switch the valve in single direction (impact from left to right). The impact from the other direction (from right to left) is invalid.
- Control joint combination can be ordered individually. Please refer to external specification.

CM3 Series

Flow chart

Model: CM3B-05

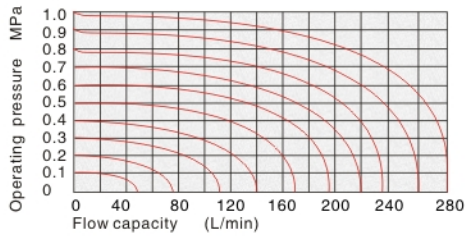

Model: CM3B-06

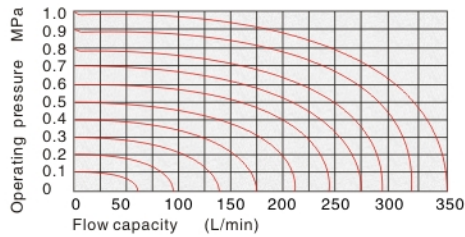

Model: CM3B-08

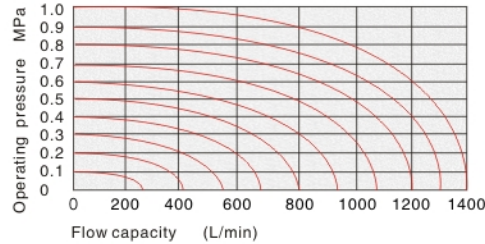

Dimension (Basic type)

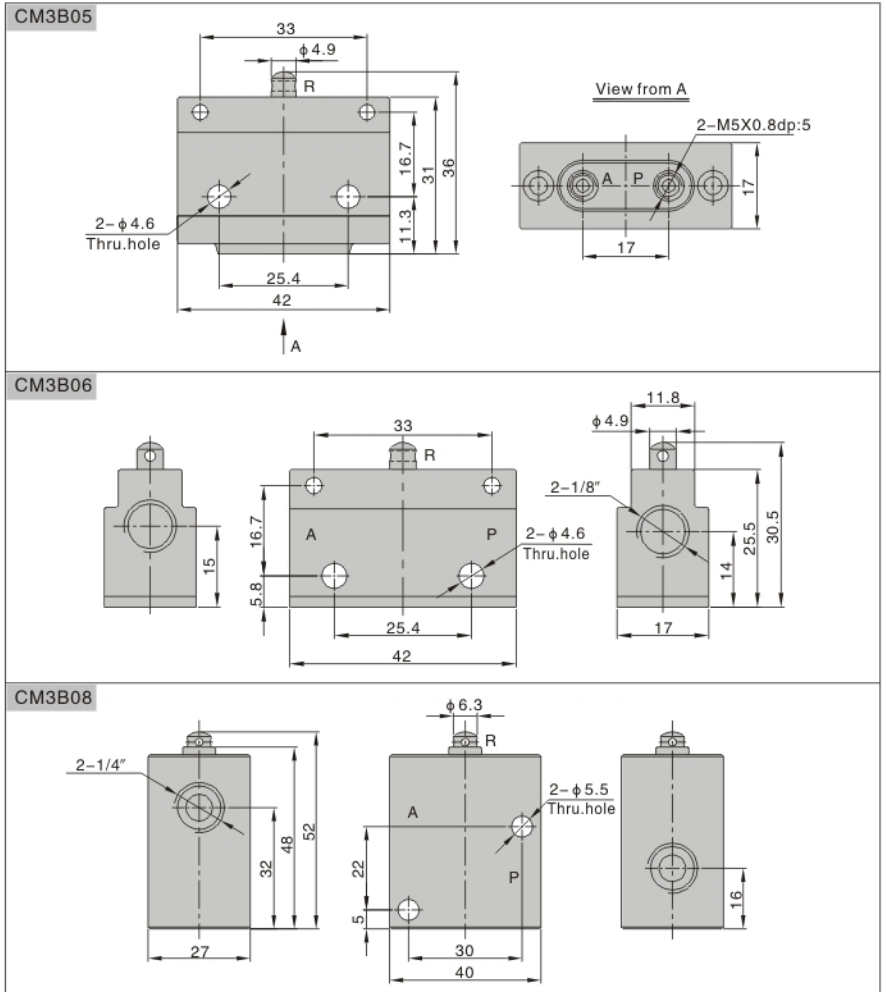

Control set dimension

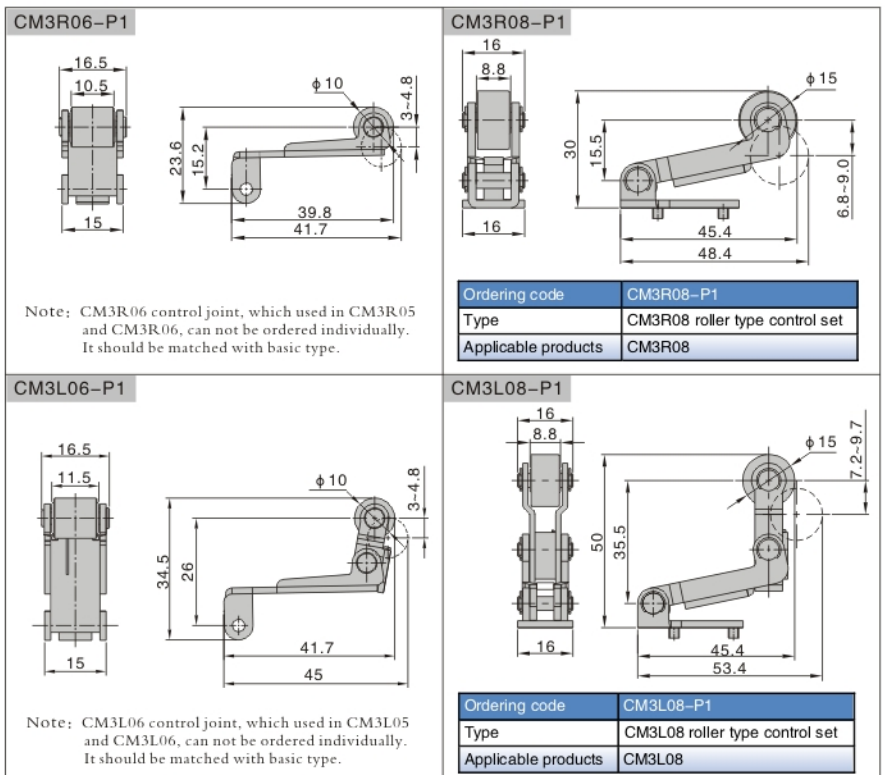

CM3 Series

CM3Y06-P1

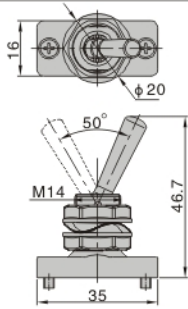

Ordering code	CM3Y06-P1
Type	CM3Y lever type control set
Applicable products	CM3Y05, CM3Y06, CM3Y08

CM3V06-P1

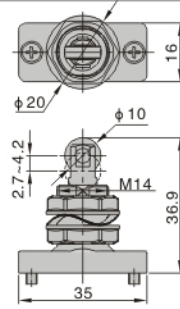

Ordering code	CM3V06-P1
Type	CM3V vertical roller type control set
Applicable products	CM3V05, CM3V06, CM3V08

CM3PL06-P2

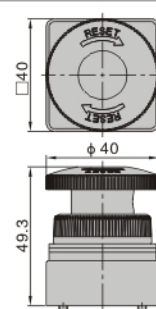

Ordering code	CM3PL06-P2
Type	CM3PL latching type control set(red)
Applicable products	CM3PL05, CM3PL06, CM3PL08

CM3PM06-P□

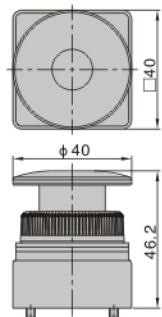

Ordering code	CM3PM06-P1
Type	CM3PM mushroom type control set (green)
Applicable products	CM3PM05, CM3PM06, CM3PM08

CM3HS06-P□

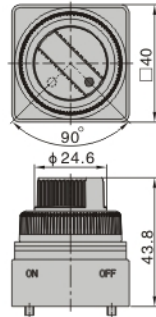

Ordering code	CM3HS06-P1
Type	CM3HS selector type control set (green)
Applicable products	CM3HS05, CM3HS06, CM3HS08

CM3PP06-P□

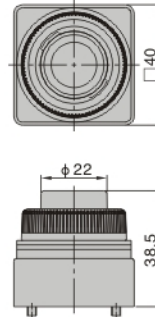

Ordering code	CM3PP06-P1
Type	CM3PP protruding type control set (green)
Applicable products	CM3PP05, CM3PP06, CM3PP08

CM3PF06-P□

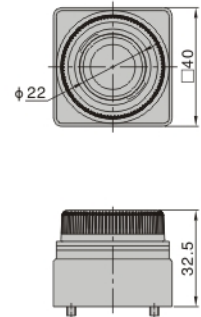

Ordering code	CM3PF06-P1
Type	CM3PF flat type control set (green)
Applicable products	CM3PF05, CM3PF06, CM3PF08

Ordering code	CM3PM06-P2
Type	CM3PM mushroom type control set (red)
Applicable products	CM3PM05, CM3PM06, CM3PM08

Ordering code	CM3HS06-P2
Type	CM3HS selector type control set (red)
Applicable products	CM3HS05, CM3HS06, CM3HS08

Ordering code	CM3PP06-P2
Type	CM3PP protruding type control set (red)
Applicable products	CM3PP05, CM3PP06, CM3PP08

Ordering code	CM3PF06-P2
Type	CM3PF flat type control set (red)
Applicable products	CM3PF05, CM3PF06, CM3PF08

Ordering code	CM3PM06-P3
Type	CM3PM mushroom type control set (black)
Applicable products	CM3PM05, CM3PM06, CM3PM08

Ordering code	CM3HS06-P3
Type	CM3HS selector type control set (black)
Applicable products	CM3HS05, CM3HS06, CM3HS08

Ordering code	CM3PP06-P3
Type	CM3PP protruding type control set (black)
Applicable products	CM3PP05, CM3PP06, CM3PP08

Ordering code	CM3PF06-P3
Type	CM3PF flat type control set (black)
Applicable products	CM3PF05, CM3PF06, CM3PF08

Ordering code	CM3PM06-P4
Type	CM3PM mushroom type control set (yellow)
Applicable products	CM3PM05, CM3PM06, CM3PM08

Ordering code	CM3HS06-P4
Type	CM3HS selector type control set (yellow)
Applicable products	CM3HS05, CM3HS06, CM3HS08

Ordering code	CM3PP06-P4
Type	CM3PP protruding type control set (yellow)
Applicable products	CM3PP05, CM3PP06, CM3PP08

Ordering code	CM3PF06-P4
Type	CM3PF flat type control set (yellow)
Applicable products	CM3PF05, CM3PF06, CM3PF08

CM3HD06-P□

CM3HD05

CM3HD06

CM3HD08

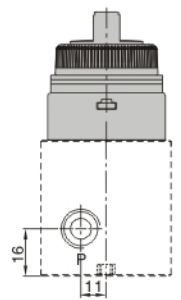
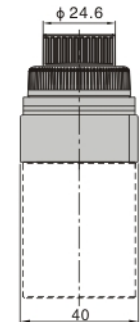
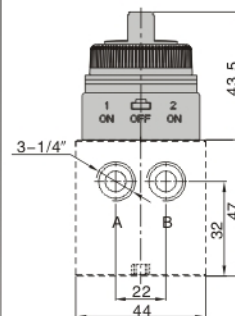
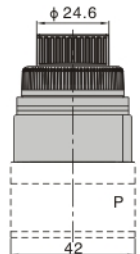
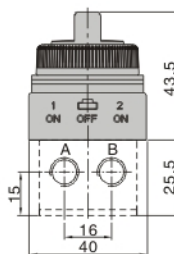
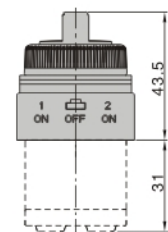
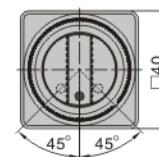
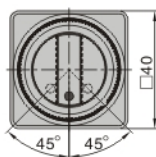
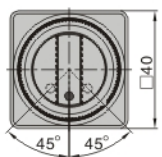

4-M5X0.8
dp:5

Ordering code	CM3HD06-P1	CM3HD06-P2	CM3HD06-P3	CM3HD06-P4
Type	CM3HD double-selector type control set (green)	CM3HD double-selector type control set (red)	CM3HD double-selector type control set (black)	CM3HD double-selector type control set (yellow)
Applicable products	CM3HD05, CM3HD06, CM3HD08	CM3HD05, CM3HD06, CM3HD08	CM3HD05, CM3HD06, CM3HD08	CM3HD05, CM3HD06, CM3HD08

Note: CM3HD control joint can be ordered individually, but should be matched with the body of CM3HD.