

# Preparation unit—GA Series

## GAR Series Regulator



### Symbol

No reflux valve is attached



Reflux valve is attached



### Product feature

1. Circular square pressure gauge which with clip and magnifier is used to save installation space.
2. The pressed-in self-locking mechanism can prevent the abnormal movement of the set pressure caused by external interfere.
3. Balanced design is adopted for the pressure adjustment mechanism.
4. In addition to panel installation, the bracket is optional for installation.

### Specification

Model	GAR200-06	GAR200-08	GAR300-08	GAR300-10	GAR400-08	GAR400-10	GAR400-15	GAR600-20	GAR600-25
Fluid	Air								
Port size [Note1]	1/8"	1/4"	1/4"	3/8"	1/4"	3/8"	1/2"	3/4"	1"
Pressure range	0.05~0.9MPa(7~130psi)								
Max. pressure	1.0MPa(145psi)								
Proof pressure	1.5MPa(215psi)								
Temperature range	-20~70°C								
Weight	170g		300g		570g			1390g	

[Note1] PT thread, G thread and NPT thread are available.

### Ordering code

**GAR300 10 S □ □ G K**

① ② ③ ④ ⑤ ⑥ ⑦

① Model	② Port size	③ Type code	④ Accessories	⑤ Pressure gauge	⑥ Thread type	⑦ Code of reflux valve
GAR200:GA200 Series regulator	06: 1/8" 08: 1/4"	Blank: Standard  L: Lower pressure [Note1]	Blank: Bracket  J: No bracket	Blank: Circular  N: No gauge	Blank: PT (MPa/psi)  G: G (bar/MPa)  T: NPT (psi/bar)	Blank: No reverse flow valve is attached  K: Reverse flow valve is attached [Note2]
GAR300:GA300 Series regulator	08: 1/4" 10: 3/8"					
GAR400:GA400 Series regulator	08: 1/4" 10: 3/8" 15: 1/2"					
GAR600:GA600 Series regulator	20: 3/4" 25: 1"					

[Note1] The maximum work pressure of lower pressure type is 0.4MPa(58psi); [Note2] Please refer to page 179 for details of reflux valve.

### Inner structure

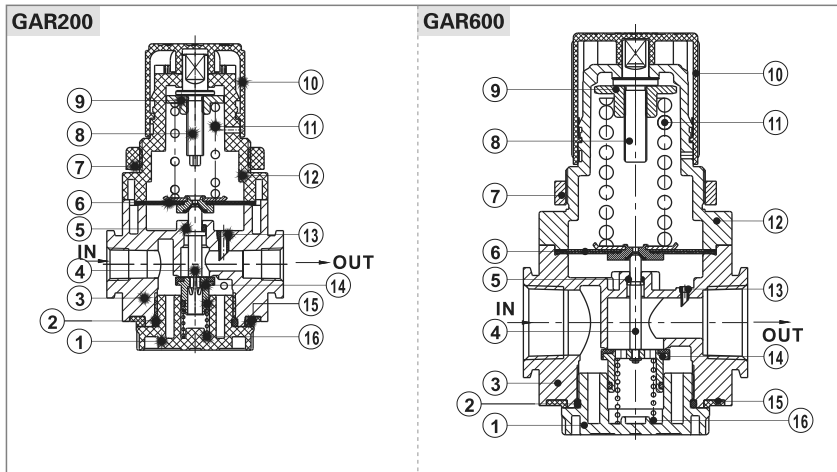

No.	Item	Material
1	Valve cap	Aluminum alloy(GR600)\POM(others)
2	O-ring	NBR
3	Body	Aluminum alloy
4	Spool	Brass(GR600)\POM(others)
5	O-ring	NBR
6	Diaphragm	NBR
7	Fixed ring	Aluminum alloy (GR600)\POM(others)
8	Adjusting spindle	Steel
9	Regulator nut	Steel
10	Pressure knob	POM
11	Pressure spring	SWPB
12	Adjusting seat	Aluminum alloy (GR600)\POM(others)
13	Feed back tube	POM
14	Pressure plug	Aluminum alloy & steel
15	Bottom cover	POM
16	Spring	SWPB

# Preparation unit—GA Series

## GAR Series Regulator

### Pressure chart

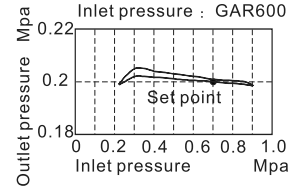
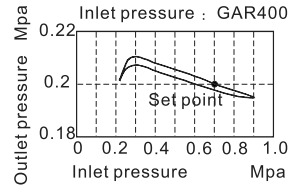
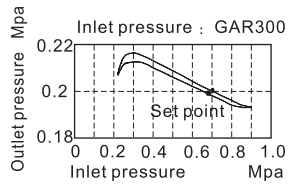
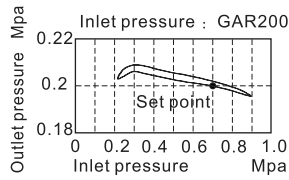

### Flow chart

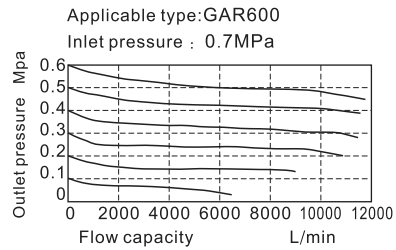
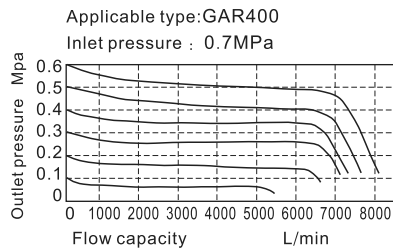
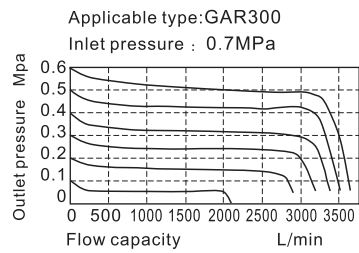
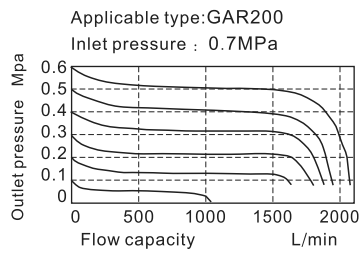

### Dimensions

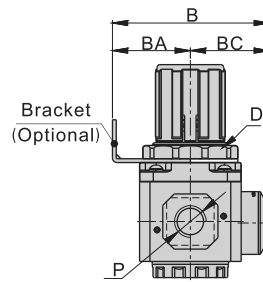
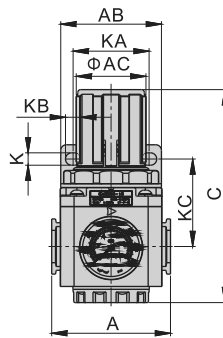

Model\Item	A	AB	AC	B	BA	BC	C	D	K	KA	KB	KC	P
GAR200-06	52.5	55	31	69	30	39	91	M33x1.5	5.5	34	15.5	45	1/8"
GAR200-08	52.5	55	31	69	30	39	91	M33x1.5	5.5	34	15.5	45	1/4"
GAR300-08	62.5	53	38	82.5	41	41.5	112	M40x1.5	6.5	40	8	46	1/4"
GAR300-10	62.5	53	38	82.5	41	41.5	112	M40x1.5	6.5	40	8	46	3/8"
GAR400-08	80	72	52	99	50	49	140.5	M55x2.0	8.5	55	11	53	1/4"
GAR400-10	80	72	52	99	50	49	140.5	M55x2.0	8.5	55	11	53	3/8"
GAR400-15	80	72	52	99	50	49	140.5	M55x2.0	8.5	55	11	53	1/2"
GAR600-20	100	90	59	128	70	58	179.5	M62x1.5	11	66	13	73.5	3/4"
GAR600-20	100	90	59	128	70	58	179.5	M62x1.5	11	66	13	73.5	1"